



A Group Company of **MITSUBISHI ELECTRIC**

---



## **QUICK GUIDE**

**C024456100-09-16-EN**

---

**EN**

September 2016

Thank you for choosing this Climaveneta S.p.A. product

### **Important note**

The written content and the images of this manual have been produced with the utmost level of care and attention. As it is not possible to exclude all types of errors, we would like you to remember the following: the basis for your projects should only consist of calculations and designs in compliance with current laws and technical regulations. We take no responsibility whatsoever for the written content and the images of this manuals, as they are only provided as mere examples. The application of any instructions of this manual is at the sole risk of the user. The issuer shall not be held responsible for any inappropriate or wrong information, or for any damage resulting from the same.

### **Notes**

We reserve the right to modify the design and the specifications without notice. Images may vary slightly when compared with the actual model.

### **Warnings**

The KIPLink<sup>®</sup> software is protected by a digital signature.

This means that it can only work on boards supplied by Climaveneta S.p.A. and not on boards purchased from other dealers.

### **Copyright**

Copyright © 2016 Climaveneta S.p.A.

This manual is protected by international copyright laws.

No part of this manual may be reproduced, distributed, translated, or transmitted in any form or using any means, either electronic or mechanical, including photocopies, recordings, or saving in any types of information databases or recovery systems, without the previous written authorisation of Climaveneta S.p.A.







# Contents

<b>1</b>	<b>INTRODUCTION</b> .....	<b>5</b>
1.1	Notes on the documentation .....	5
1.2	Product description .....	6
1.3	Conditions of use .....	6
<b>2</b>	<b>PRODUCT OVERVIEW</b> .....	<b>8</b>
2.1	KIPLink: models and sizes .....	8
2.2	Technical characteristics .....	9
2.3	Hardware description .....	10
2.3.1	Notification LED .....	10
2.3.2	Communication ports and terminals .....	11
<b>3</b>	<b>GENERAL INFORMATION</b> .....	<b>13</b>
<b>4</b>	<b>INSTALLATION</b> .....	<b>14</b>
<b>5</b>	<b>CONFIGURATION OF THE KIPLINK PARAMETERS</b> .....	<b>14</b>
<b>6</b>	<b>UNIT CHECK</b> .....	<b>15</b>
6.1	Access using the CV APP .....	15
<b>7</b>	<b>USER INTERFACE</b> .....	<b>16</b>
7.1	Homepage .....	16
7.2	Language setup .....	17
7.3	Switching the unit on and off .....	18
7.4	Date and time setup .....	19
7.5	Hardware and Software information .....	20
7.6	Unit Setpoint setup .....	21
<b>8</b>	<b>KIPLINK NETWORK</b> .....	<b>22</b>
8.1	Network infrastructure .....	23
<b>9</b>	<b>DISPOSAL</b> .....	<b>25</b>

# 1 INTRODUCTION

## 1.1 Notes on the documentation

- Before using the device, carefully read this manual. Make sure that you keep this manual in a safe place for future reference.
- The original documentation is written in English language. The documentation in other languages has been translated.
- In the manual are some symbols that highlight some sections of the same. In particular:

	<b>MANUAL</b> It indicates those sections that must be read with particular care.
	<b>NOTE</b> It indicates useful suggestions or additional information.
	<b>USER</b> It indicates information that is particularly useful for the user.
	<b>ATTENTION</b> It indicates parts to which particular attention must be paid for the purpose of safety.

## 1.2 Product description

KIPlink (“Keyboard In your Pocket” KL for short) is an electronic device for interfacing with Climaveneta units using Wi-Fi Client devices (Tablet or Smartphone); the device is also capable to log some information on the operation of the unit on a removable internal memory.

The information made available by the KL device can be used on a CV App installed in the Client device used for interfacing.

**i** *Note:* for Service applications only, a Personal Computer (PC) can be used as Client interfacing device

## 1.3 Conditions of use

### • **Controller**

The KIPlink device is compatible with all Climaveneta units fitted with W3000TE, Evolution+, or CX-4 electronic controllers.

The KL device collects information, which is then made available to the user directly from the controller. For correct operation, the following software requirements must be met:

KIPlink device	Unit controller	Controller software
W3000link	W300TE	LA13 or higher
EVOLUTIONlink	EVOLUTION+	ME08 or higher
CXlink	CX-4	PS01 or higher

### • **Client Devices**

Wi-Fi Client devices to be used for interfacing with the KIPlink device must meet the following hardware and software requirements:

<b>Hardware</b>	Tablet or Smartphone with Wi-Fi IEEE 802.11n or 802.11g connection, and at least 100MB of available storage space.
<b>Software</b>	<p>Operating system: Android 5 or higher / IOS 8 or higher / Windows 10 or higher.</p> <p>Climaveneta® App, registered and available for download from Google Play®, Apple Store® and Microsoft Store®.</p> <p><b>i</b> <i>Note:</i> when using a PC for Service applications, the use of Google® Chrome 50.0 or higher is recommended.</p>



Installations and uses other than those indicated in this manual are forbidden.

**i** Note: for more information on the KIPlink device, refer to the KIPlink device User Manual for the type of device installed in the machine:

<b>KIPlink device</b>	<b>Cod. KIPlink user manual</b>
W3000link	C024456140-IT, C024456141-EN, C024456142-FR C024456143-DE, C024456144-ES, C024456145-RU C024456146-ML
EVOLUTIONlink	C024456150-IT, C024456151-EN, C024456152-FR C024456153-DE, C024456154-ES, C024456155-RU C024456156-ML
CXlink	C024456120-IT, C024456121-EN, C024456122-FR C024456123-DE, C024456124-ES, C024456125-RU C024456126-ML

## 2 PRODUCT OVERVIEW

### 2.1 KIPlink: models and sizes

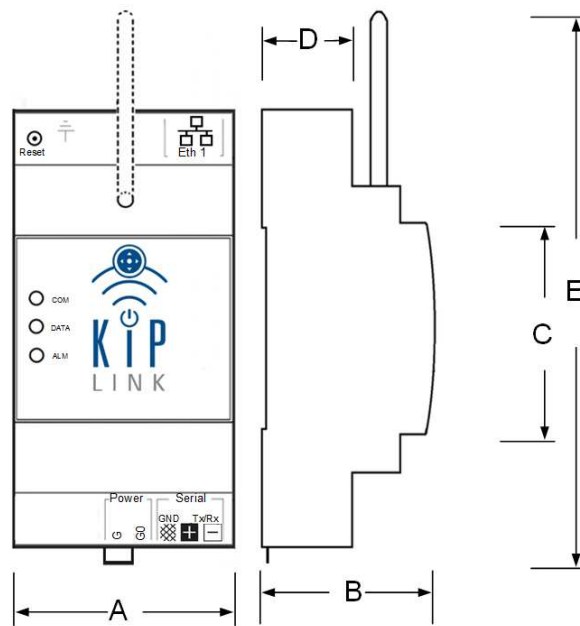

**KIPlink Earth**

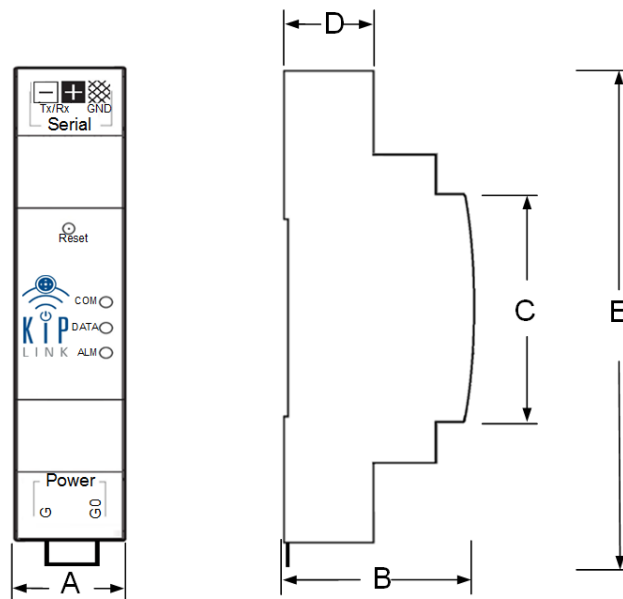

**KIPlink Moon**

	KIPlink Earth (mm)	KIPlink Moon (mm)
A	54	18
B	62	62
C	45	45
D	33	20
E	195	100



## 2.2 Technical characteristics

<b>Characteristic</b>		<b>KIPlink Earth</b>	<b>KIPlink Moon</b>
<b>MAXIMUM SIZES (LxWxH)</b>		54 mm X 62mm X 100mm	18 mm X 62mm X 195mm
<b>WEIGHT</b>		300 g	250 g
<b>POWER INPUT</b>		24V AC/DC	24V AC/DC
<b>CONSUMPTION</b>		< 6 W	< 6 W
<b>PORTS</b>		1xRS485 1xLAN (RJ-45 10/100 Mbit/s)	1xRS485
<b>CONNECTIVITY AND PROTOCOLS</b>		External Wi-Fi aerial (2.5 dBi). "Remote aerial kit" available on request	Internal Wi-Fi aerial (not to be used remotely)
		RS485 serial (Modbus RTU Master protocol toward the controller)	RS485 serial (Modbus RTU Master protocol toward the controller)
		10/100 Mbps Ethernet (Modbus TCP/IP Server protocol toward the controller)	NO Ethernet port
<b>WI-FI MODULE *</b>	<b>STANDARD</b>	IEEE 802.11n - 802.11g	IEEE 802.11n - 802.11g
	<b>FREQUENCIES</b>	2.4-2.4835 GHz	2.4-2.4835 GHz
	<b>OUTPUT POWER</b>	< 20 dBm	< 20 dBm
	<b>SAFETY</b>	WPA2	WPA2
	<b>FLOW</b>	< 20 m	< 20 m
<b>FIREWALL</b>		IP Filtering Network Address Translation (NAT) MAC Filtering	IP Filtering Network Address Translation (NAT) MAC Filtering
<b>HISTORY (log files - events)</b>		500 max – 600 days approx	200 max – N.A.
<b>ARCHIVE MEMORY</b>		Industrial 1GB microSD Card for device update and history log storage	MicroSD slot
<b>LED</b>		Power input, controller communication Wi-Fi transmission	Power input, controller communication Wi-Fi transmission
<b>RESET BUTTON</b>		YES	YES
<b>OPERATING TEMPERATURE</b>		-20°C to +60°C	-20°C to +60°C
<b>STORAGE TEMPERATURE</b>		-55°C to +100°C	-55°C to +100°C
<b>OPERATING HUMIDITY</b>		RU 10% TO 95%	RU 10% TO 95%
<b>START-UP TIME</b>		From the moment the power input is reinstated: approximately 1 minute	From the moment the power input is reinstated: approximately 1 minute
<b>PLASTIC CASE</b>		3 DIN module rail	1 DIN module rail
<b>IP DEGREE</b>		IP20	IP20
<b>CERTIFICATES</b>		CE	CE



\* This device must be installed and used at a minimum distance of 20 cm from the body. This sentence is also to be considered as a general declaration for the considerations on the environment of use.

## 2.3 Hardware description

### 2.3.1 Notification LED

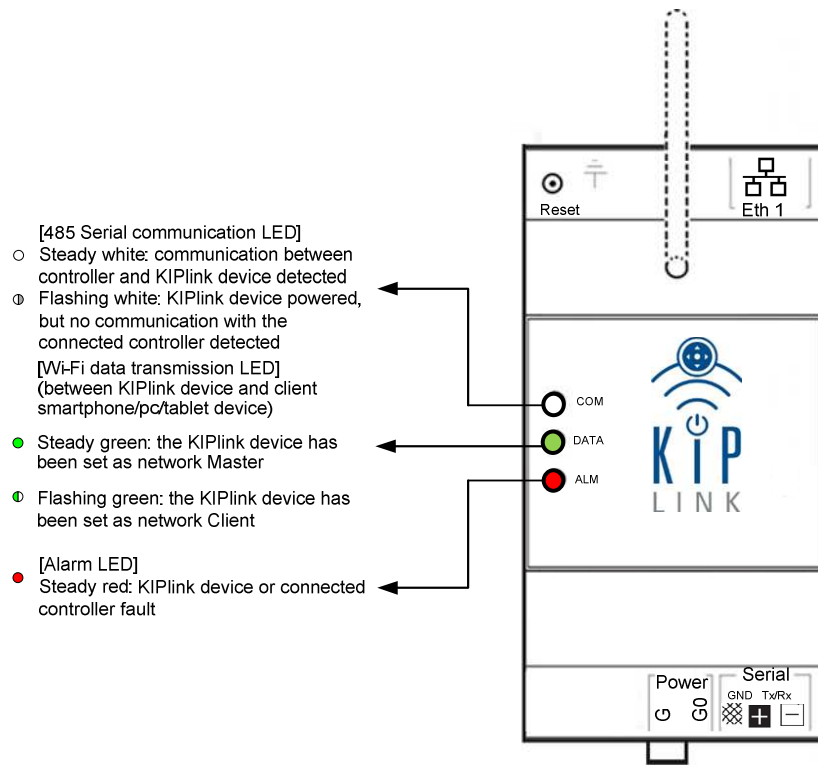

**KIPlink Earth**

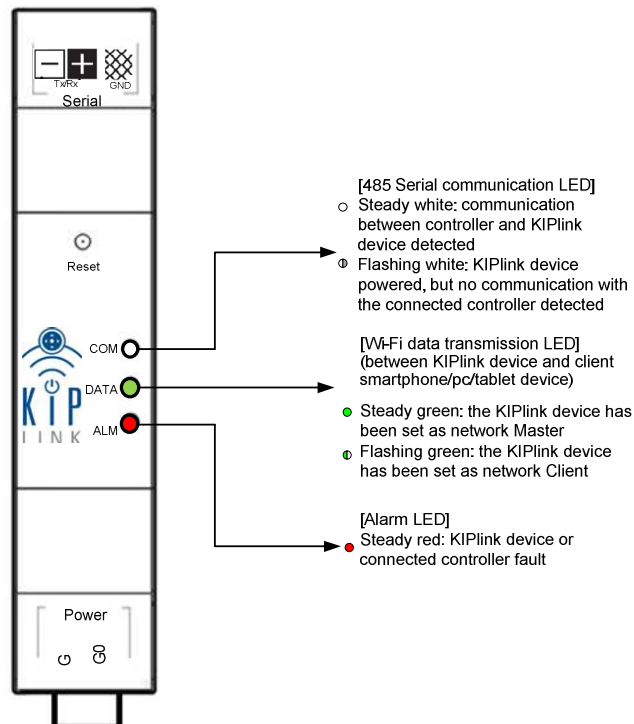







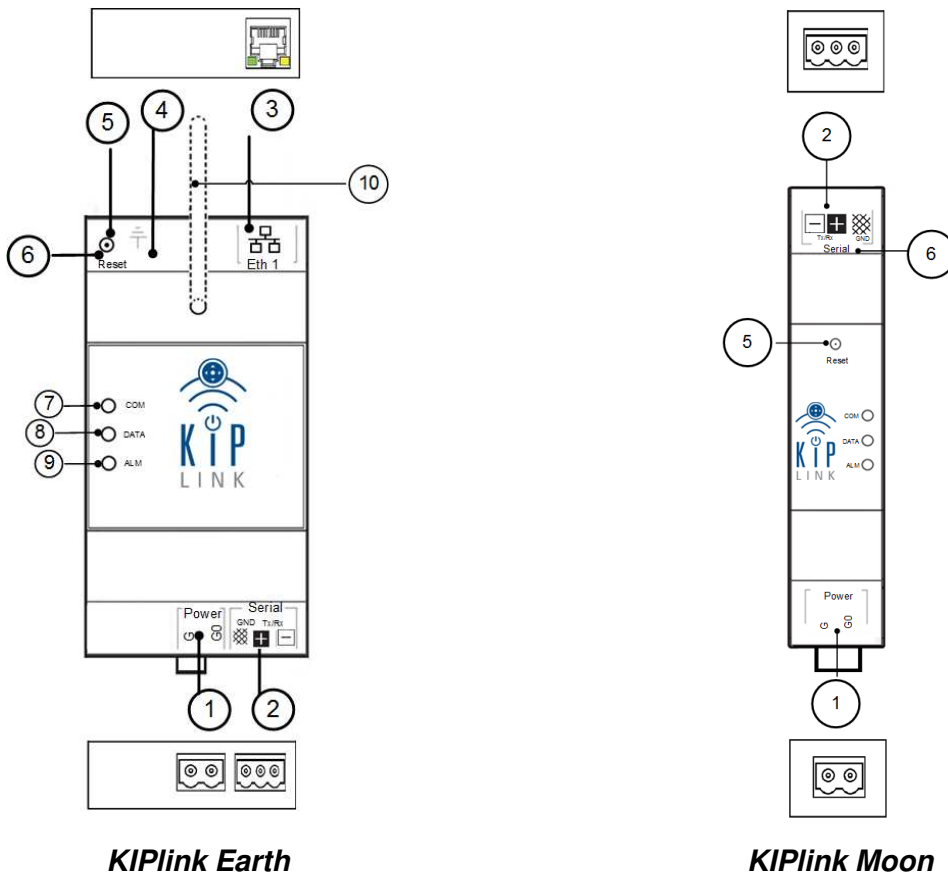

**KIPlink Moon**

**i** **Note:** upon start-up, or when the network settings are received from the keypad, the 3 LEDs come on at the same time for approximately 2 seconds.

### 2.3.2 Communication ports and terminals



1	Power input
2	Serial RS485 for communication with the control
3	Ethernet: service
4	Functional Earth
5	Reset Button
6	Storage memory slot (below the removable cover)
7	COM LED - RS485 serial traffic
8	DATA LED - Wi-Fi data traffic between the KIPlink and the Client device (Smartphone / PC / Tablet)
9	ALM LED - alarm
10	External Wi-Fi aerial with male connector for aerial extension, to install outside the electric panel

<b>Terminal</b>	<b>Description</b>	<b>Remarks</b>
<b>Power</b> G, G0	Power supply (24V AC/DC)	 G0 is normally connected to the earth in the electric panel. In this case, before powering the KIPLink device, check that the polarity between G and G0 is correct.
<b>GND</b> 	RS485 connection terminal (Modbus RTU® protocol)	 Terminal that must only be connected when the KIPLink device is connected outside the electric panel/to a different power input.   <i>Note:</i> in this case, it will be necessary to install an opto-isolator between the controller serial port and the KIPLink device serial port, or insulation on the power inputs.
<b>Tx/Rx</b> 	RS485 connection terminals (Modbus RTU® protocol)	Use a shielded cable, connecting one end of the cable shield to the earth.
<b>Eth 1</b> 	Service 1 or TCP/IP connection 10/100 Ethernet (Modbus TCP/IP® protocol)	The use of an Ethernet cable of CAT6 or higher is recommended.
	Functional Earth (KIPLink Earth model only)	To be connected only when the Ethernet port is connected.   <i>Note:</i> if the J1 jumper is connected (only visible when opening the case), G0 must be connected to the earth using this terminal.

 **Notes:**

1. When the device is switched on, wait approximately 40 second for the start-up sequence to be completed (during this stage, the COM LED will be on steady, and the ALM LED will be a weak intensity red colour).
2. After the start-up sequence has been completed, or when the network settings are received from the keypad, the 3 LEDs will come on at the same time for approximately 2 seconds.
3. Earth model only: after being switched off, the device remains on for approximately 1 minute; this time is used to close all open applications and complete any appropriate data backups.

### 3 GENERAL INFORMATION



This unit must only be used as specifically intended. All other use is deemed improper and therefore hazardous. The manufacturer rejects all liability for damage resulting from improper, incorrect or unreasonable use.



The device may be **powered both at 24V continuous current (Vdc) or 24V alternate current (Vac)**. Pay attention to the polarity of the G and G0 terminals.

The electric connection must only be completed by qualified personnel, in accordance with current regulations.



Different input voltage and current values may damage the device.



If used at particularly low temperatures, the time it takes for the device to switch back on may increase significantly (up to 4 minutes).

This is normal and does not indicate a malfunction.



The device user interface can only be accessed using the Climaveneta App, which must be registered and installed on compatible Client devices. Communication with the KIPLink module and the Client devices is only possible through the Wi-Fi network.



*Note:* for Service application only, a PC can also be used as Client, with Wi-Fi connection to the KIPLink module.



Before connecting the power to the KIPLink device, check that the connections and/or the Power / Serial terminals have not been inverted.

Connecting the power input to the Serial terminal of the KL device can damage the communication port.

## 4 INSTALLATION

 The installation of the KIPLink device must be completed by qualified and experienced personnel, in full compliance with current regulations.

 *Note:* for more details on the electric and communication connections for the installation of the KL device in the unit, refer to the KIPLink device Installation Manual.

## 5 CONFIGURATION OF THE KIPLINK PARAMETERS

 The settings of the KIPLink device Wi-Fi and/or Ethernet network parameters can be customised using the controller user interface (EVOLUTION+ display, W3000 large, W3000 compact or W3000 touch), or using the KL Service application. The setup operations must be completed by qualified and experienced personnel.

 *Note:* for more details on the setting up of the Service masks associated with the KL network parameters, refer to the corresponding KIPLink device Installation Manuals and to the controller Technical Manual:

Controller	Cod. KIPLink installation manual	Cod. Technical manual Controller
W3000 TE	C024456103-IT-EN	C0240013-IT, C0240013-EN
EVOLUTION +		C01002388H-IT, C01002512H-EN
CX-4		-

 If the KL device network factory settings are changed, the QR Code may no longer be suitable for access using the App.

## 6 UNIT CHECK

### 6.1 Access using the CV APP

After installing the KL device in the CV unit, to access and control the machine download - using a Tablet or Smartphone with Android 5 or higher / IOS 8 or higher / Windows 10 or higher -, the Climaveneta® App from Google Play®, Apple Store® and Microsoft Store®.



Open the APP\*, scan the QR Code found on the machine\*\* and connect to the KIPLink device through the Wi-Fi network following the instruction shown on the display. After this, go to the unit control using the button found in the App.

 \* The first time the KIPLink section is accessed, the user must register to obtain authorisation for using the unit control.

 \*\* On the machine is a KIPLink device adhesive label with the encrypted QR Code, which can only be read using the Climaveneta® App. In addition to the QR Code, there is also further information regarding the serial number of the machine on which the KIPLink device is installed and, in case of networks consisting of several KIPLink devices, if the device is the network Master (for more details see *Chapter 8*).

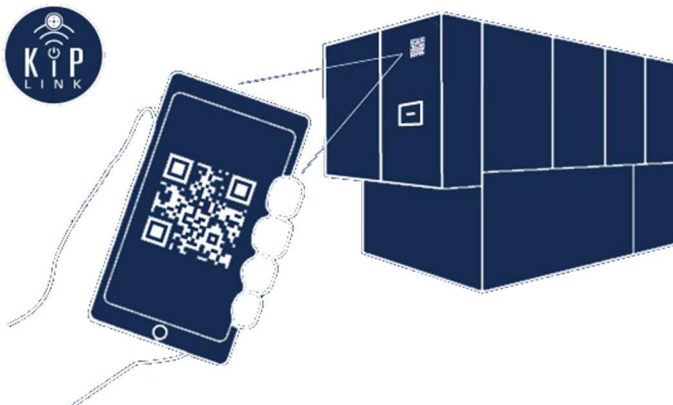

Example of KIPLink QR Code

#### Notes:

1. If the QR Code on the machine is damaged or missing, contact technical support for a replacement code.
2. For more information on the use of the Climaveneta APP on a Tablet / Smartphone, see the TUTORIAL section of the App itself.

## 7 USER INTERFACE

### 7.1 Homepage

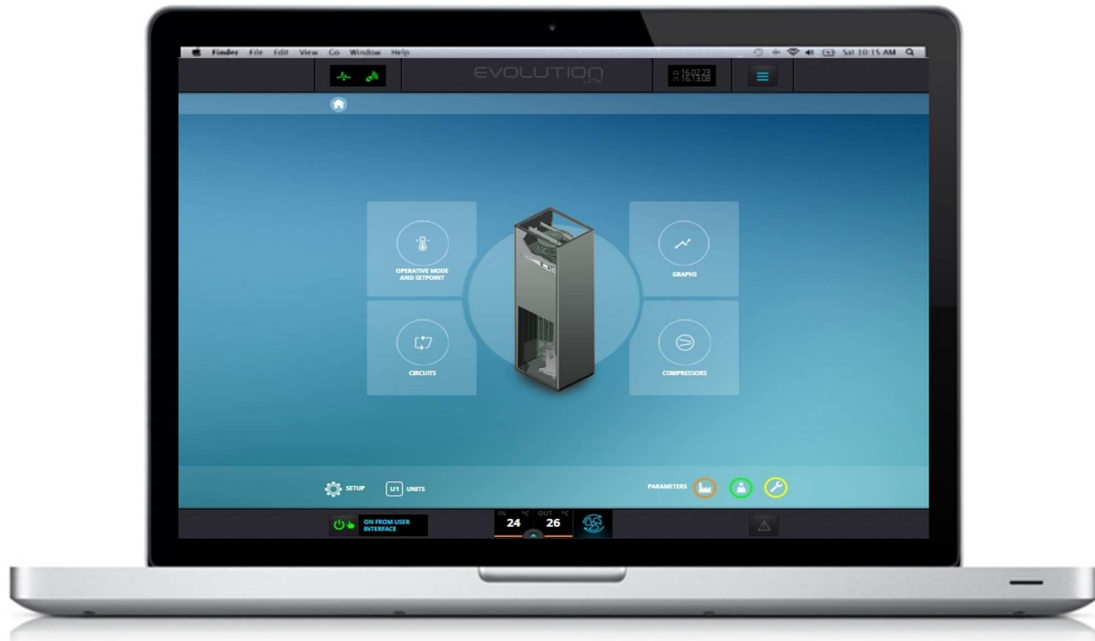

**Notebook version**



**Mobile version**



**Tablet version**

**i** *Note:* the image of the main mimic diagram shown in the figures in this manual is indicative as it is for a certain type of machine by Climaveneta S.p.A.; it may not, therefore, be exactly the same as that shown on the user interface of the control unit.



## 7.2 Language setup

To change the language of the user interface, proceed as follows:

- In the Homepage, select the "Setup" icon/button, or from any other screen select the "Quick Menu", followed by the "Setup" menu.  
In the language tab, select the desired language.

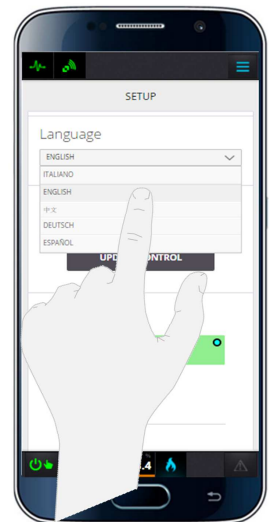
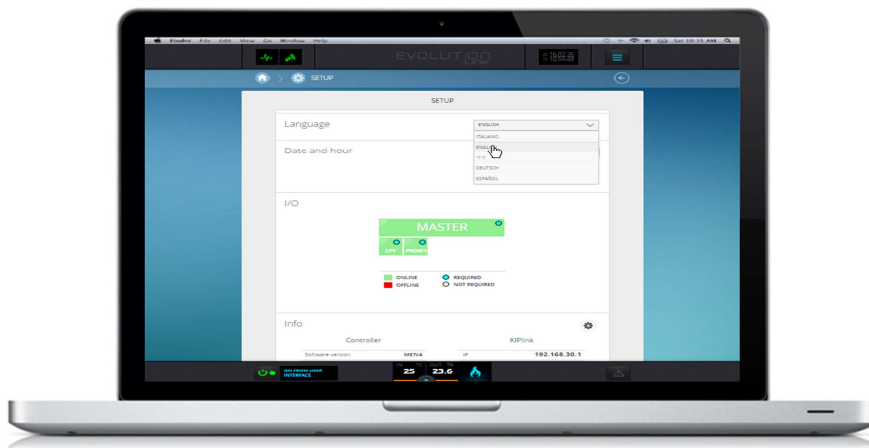

### 7.3 Switching the unit on and off

To switch the unit on or off:

- On any screen, press the ON/OFF button on the far left of the bottom bar.

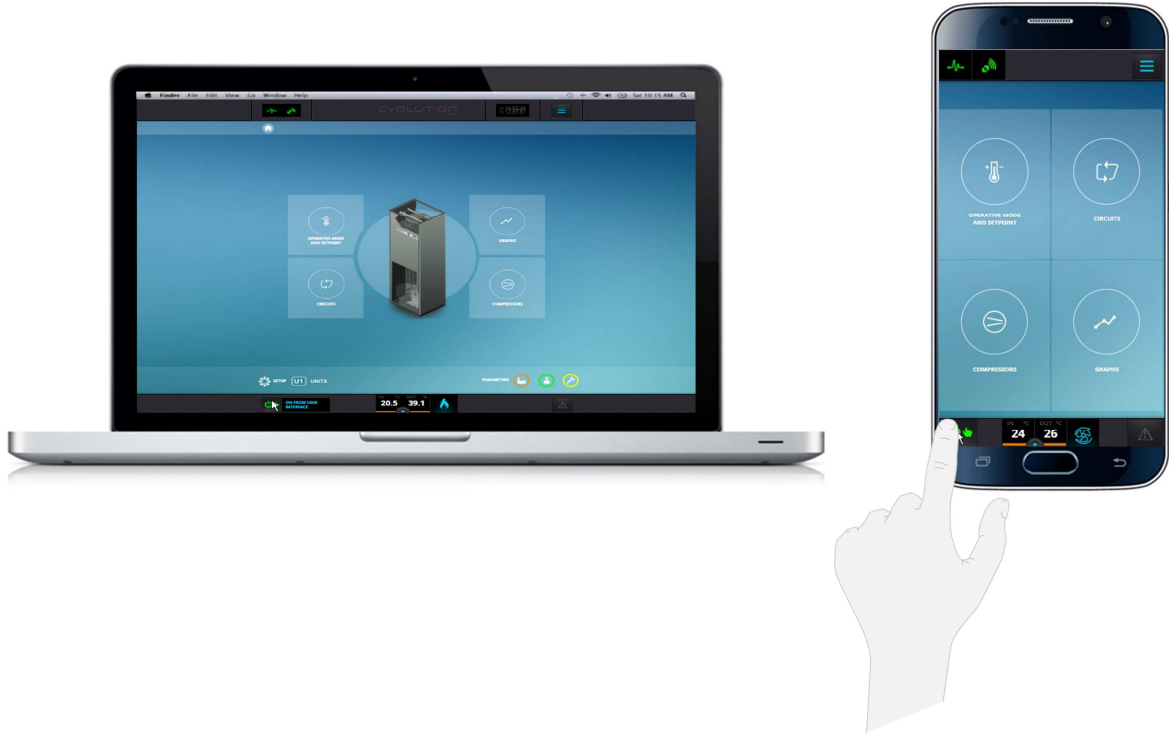

A screen will appear, asking to confirm that you want to switch on the unit ("Switch on"), or cancel the operation ("Close"). The same procedure is required for switching off.

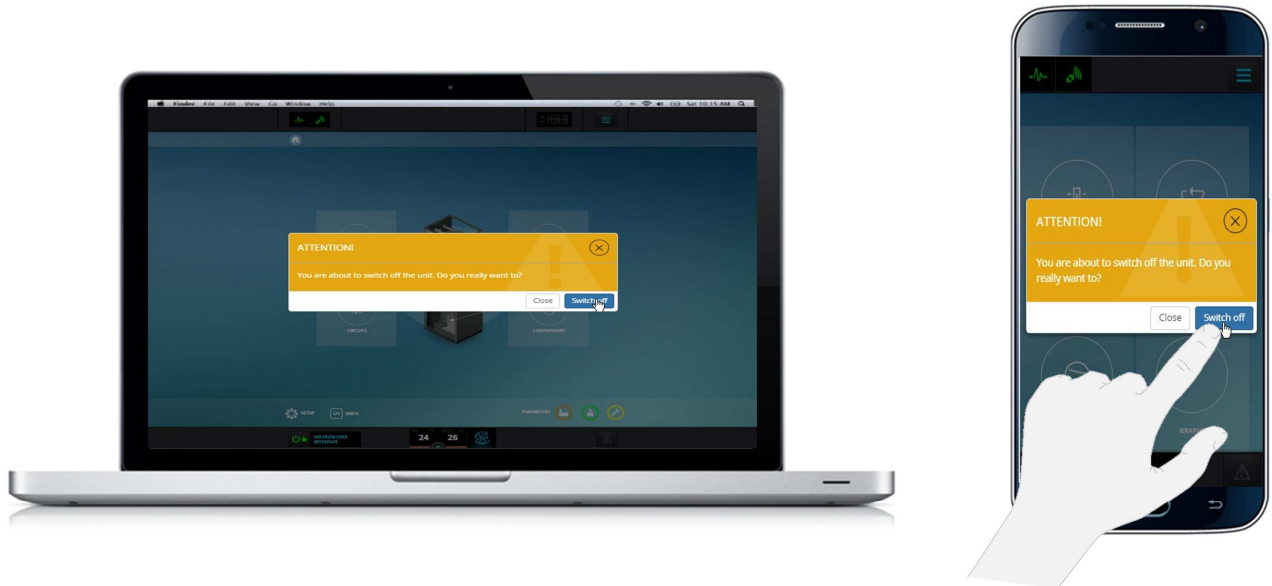

## 7.4 Date and time setup

To change the date and time, perform the following operations:

- In the Homepage, select the "Setup" icon/button, or from any other screen select the "Quick Menu", followed by the "Setup" button (as for setting the language). Go to the "Time and date" tab and set the desired parameters using the appropriate interface. Press "Update control date/time" to confirm.

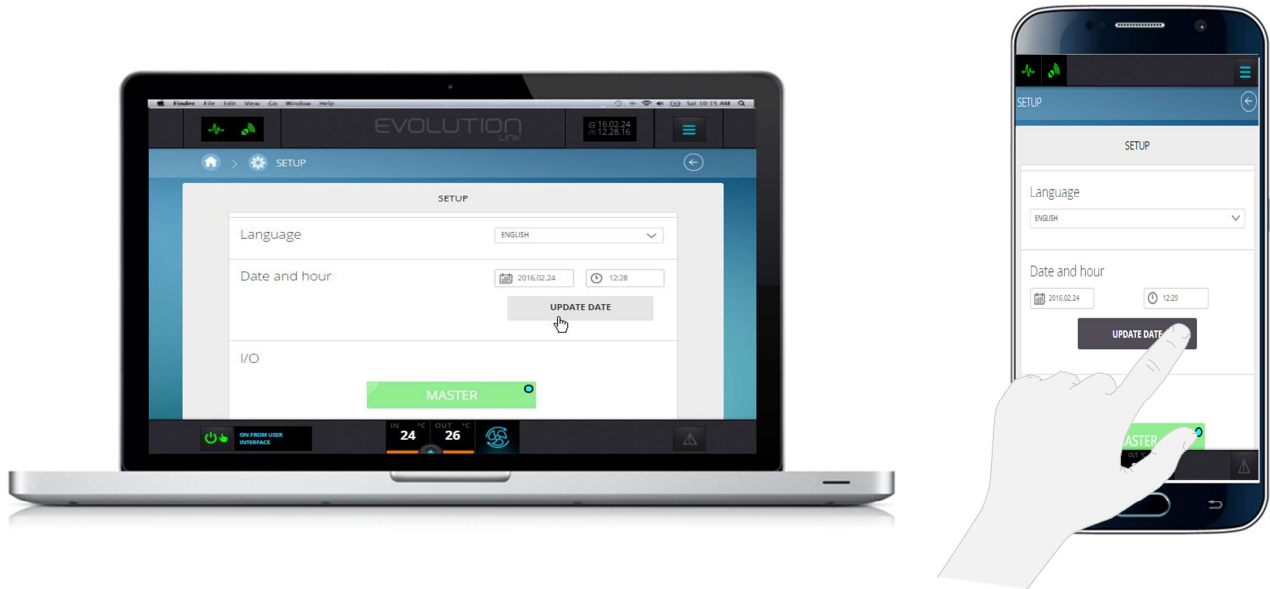

## 7.5 Hardware and Software information

It is possible to display some information associated with the controller and the KIPLink device hardware and software configuration.

- In the Homepage, select the "Setup" icon/button, or from any other screen select the "Quick Menu", followed by the "Setup" button. (as for setting the language). Open the dedicated hardware and software information tabs.

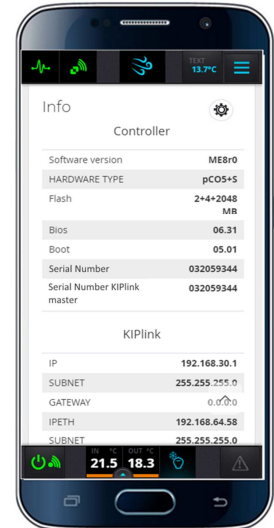
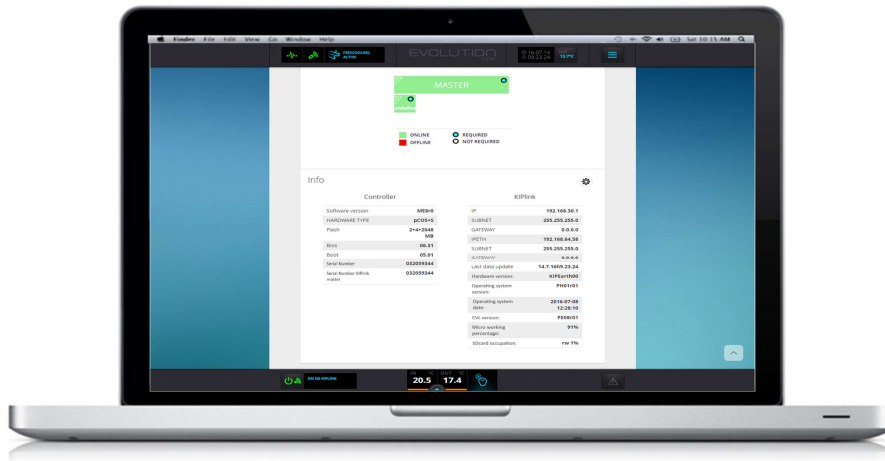

## 7.6 Unit Setpoint setup

To change the Setpoint settings:

- In the Homepage, select the "Operating Mode and Setpoint" icon/button, or from any other screen select the "Quick Menu", followed by the "Operating Mode and Setpoint" icon/button. In the screen that appears, select the temperature value to change. Enter the new value using the appropriate interface and press "Send" to confirm.

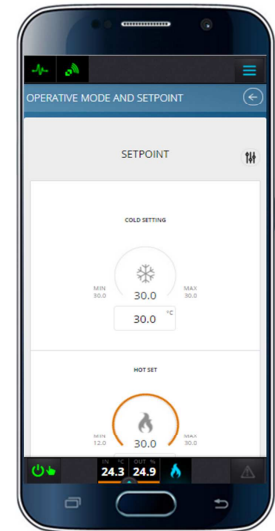
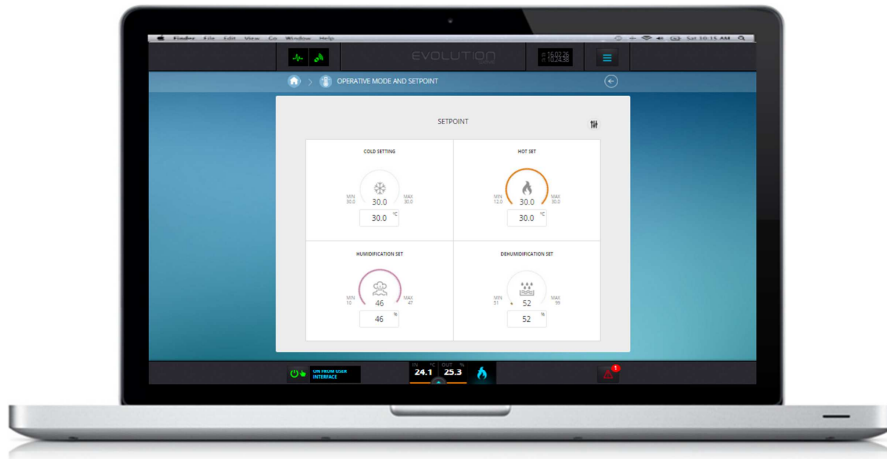

## 8 KIPLINK NETWORK

It is possible to set up mixed networks consisting of several KIPLink devices (10 maximum), to display information from different devices (called Client KL) on one single device (called Master KL). The information is collected from the various Client KL devices connected to EVOLUTION+ / W3000TE / CX-4 controllers, and sent through the Wi-Fi or Ethernet network to the Master KL device, which stores them and makes them available through an appropriate user interface.

An example of a network consisting of several KIPLink devices is shown in the figure that follows:

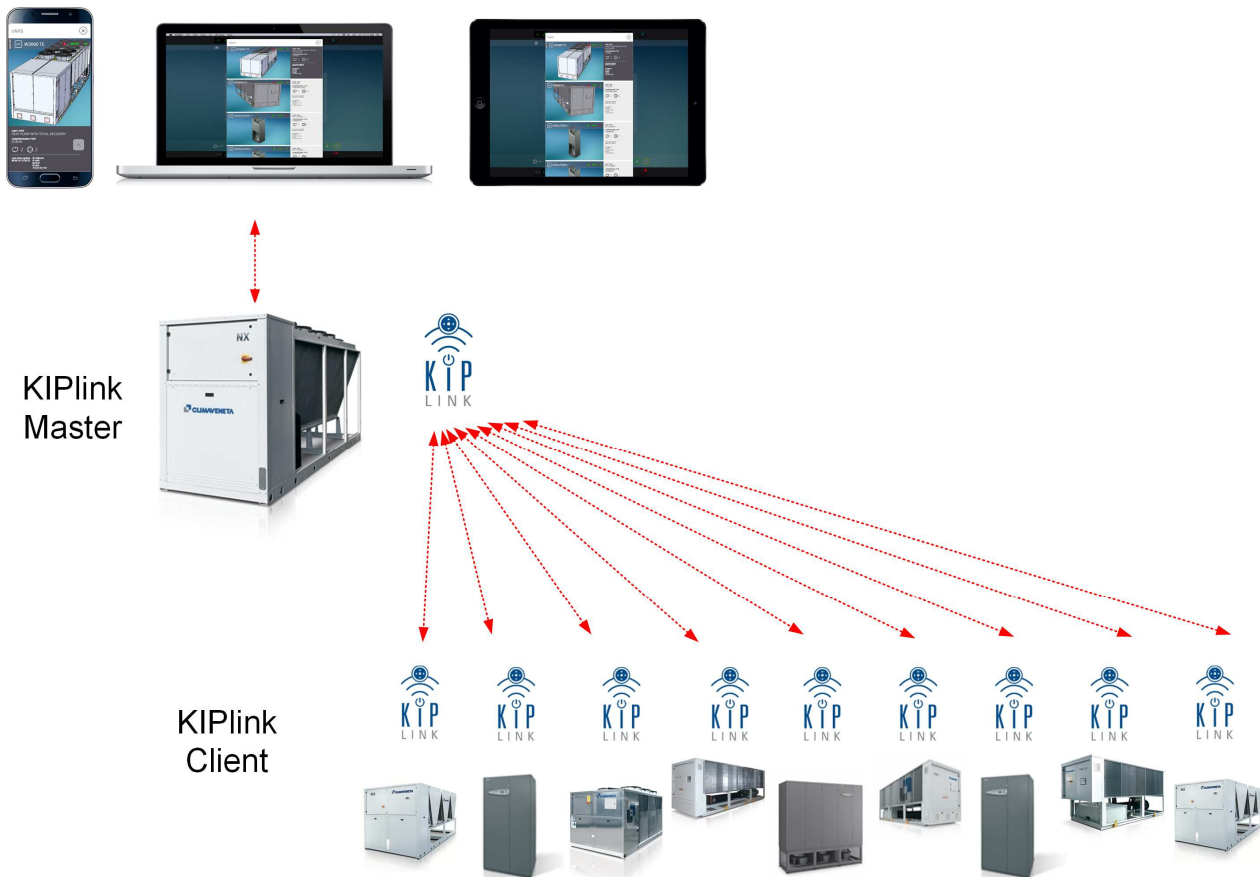

### **i** Notes:

1. For the description of the procedure for accessing and displaying the user interface in case of networks consisting of several KL devices, see *Chapter 5*.
2. The network Master KL is identified by a tick on the relevant QR Code under "Master Unit (*Chapter 6*)
3. In case of machines with EVOLUTION+ controller, the KIPLink network does not replace/integrate the function of the LAN local network, which is completed by connecting to each other controllers of several units as indicated in the Controller Technical Manual.

## 8.1 Network infrastructure

The connection for forwarding information from Client KL devices to the Master KL device can be completed using different types of networks. Wi-Fi only, Ethernet only, or mixed connections are available.

Both Earth and Moon type KIPLink devices can be used at the same time in the various modes.

### 1. Networks of several KIPLink devices with Wi-Fi connection

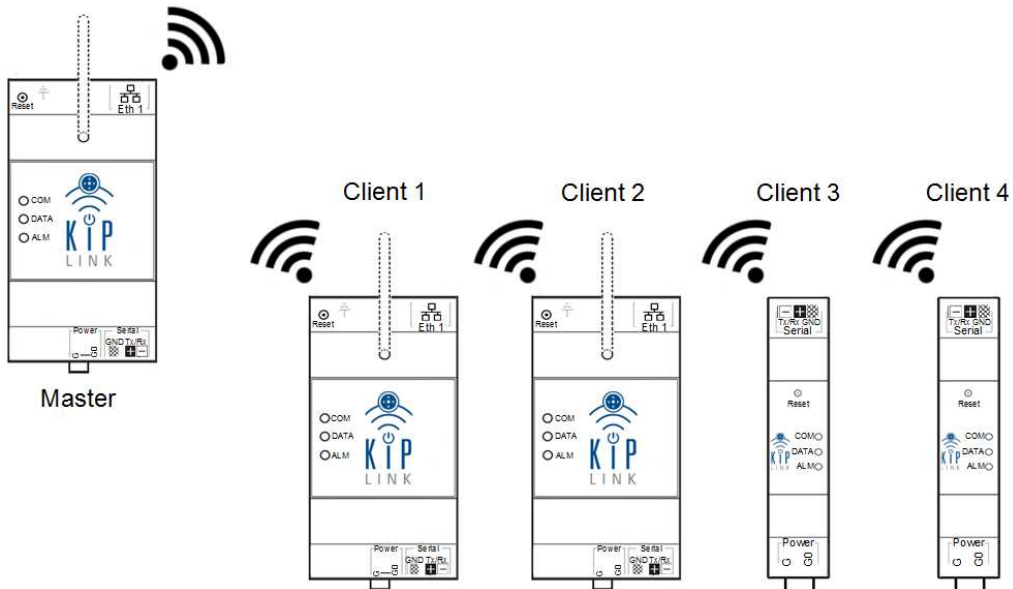

### 2. Networks of several KIPLink devices with Ethernet connection

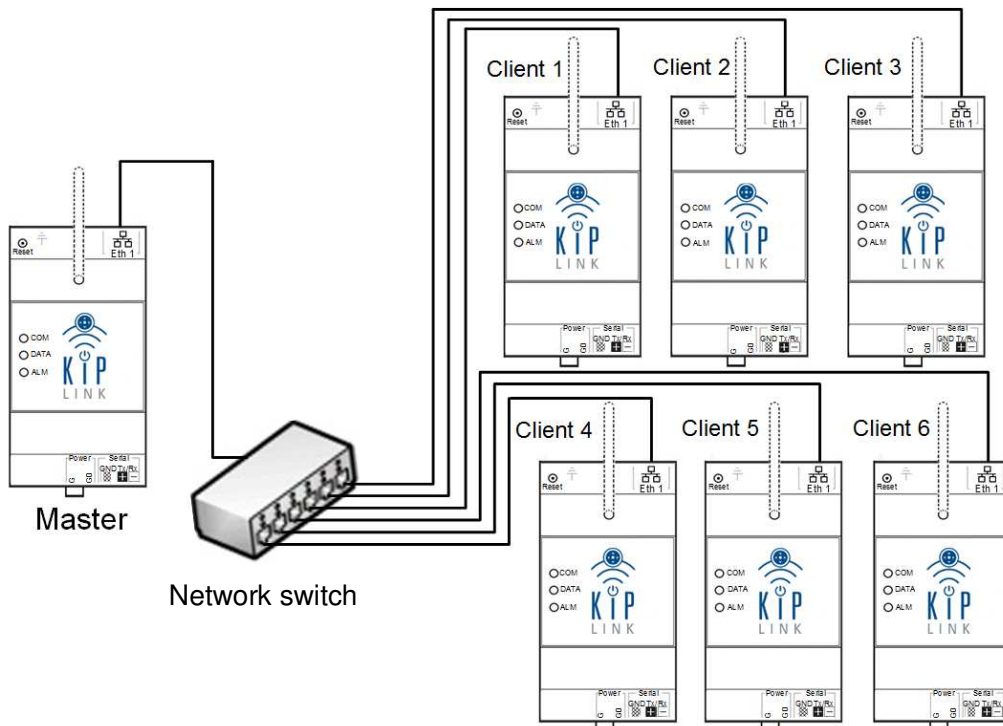

### 3. Networks of several KIPLink devices with mixed Ethernet and Wi-Fi connection

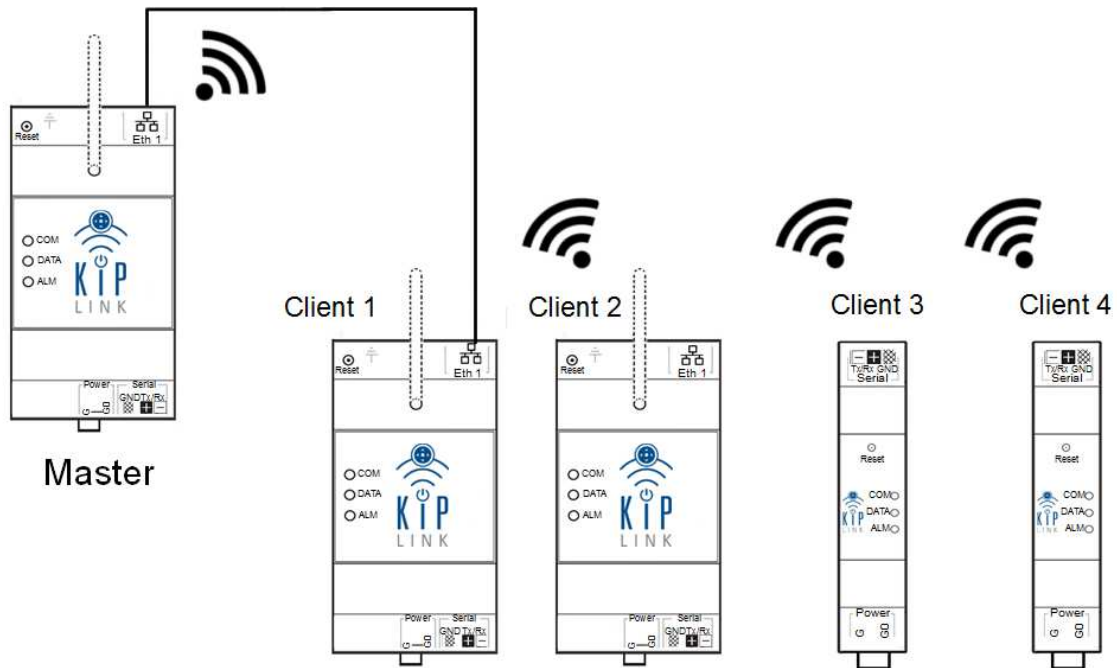

#### **i** Notes:

1. For the network settings see *Chapter 5*.
2. In case of connections different from those indicated, refer to the KIPLink device Installation Manual.
3. If the Wi-Fi signal is weak, an "External aerial kit" is available for Earth KIPLink devices, to repeat the signal outside the electric panel.



## 9 DISPOSAL

### PACKAGING DISPOSAL

Packaging materials (cardboard, plastic, etc.) can be treated as standard solid city waste. Therefore, compliance with the sorting requirements for city waste is all that is required.

Before disposing of the packaging material, always refer to the specific regulations of the country of disposal.

### **DO NOT DISPOSE OF THE PRODUCT IN THE ENVIRONMENT**

### PRODUCT DISPOSAL

Our products are made using different materials. Most of them (plastic and electric cables) can be treated as standard solid city waste. They can be recycled by taking them at authorised centres for sorted disposal.



Other components (electronic cards) may contain pollutants.

Therefore, they must be removed and handed over to companies authorised for their recovery and disposal.

Before proceeding, always refer to the specific regulations of the country of disposal.

### **DO NOT DISPOSE OF THE PRODUCT IN THE ENVIRONMENT**





A Group Company of **mitsubishi electric**

### **Climaveneta SpA**

Via Sarson 57/c  
36061 Bassano del Grappa (VI)  
Italy  
Tel +39 0424 509 500  
Fax +39 0424 509 509  
info@climaveneta.com  
[www.climaveneta.com](http://www.climaveneta.com)

### **Subsidiaries**

France  
[www.climaveneta.fr](http://www.climaveneta.fr)

Spain  
[www.climaveneta.es](http://www.climaveneta.es)

Poland  
[www.climaveneta.pl](http://www.climaveneta.pl)

Germany  
[www.climaveneta.de](http://www.climaveneta.de)

Great Britain  
[www.climaveneta.co.uk](http://www.climaveneta.co.uk)

Russia  
[ru.climaveneta.com](http://ru.climaveneta.com)  
<http://ru.climaveneta.com/>

China  
[www.climaveneta.com.cn](http://www.climaveneta.com.cn)

India  
[www.climaveneta.in](http://www.climaveneta.in)

Middle East  
[ae.climaveneta.com](http://ae.climaveneta.com)

Southeast Asia  
[www.climaveneta.com](http://www.climaveneta.com)

Hong Kong  
[www.climaveneta.com](http://www.climaveneta.com)



For more information:  
[www.climaveneta.com](http://www.climaveneta.com)